



# JOY 450

"Lots to Love less to spend!"

## Standart Machine Includes:



- Stretch Tensioner
- Automatic Top Presses
- Automatic Cutting System
- Motorised Belt Conveyors

### MACHINE TECHNICAL SPECIFICATIONS

Net Passing Diameter (mm)	450
Standart Dimensions (WxHxL)	1150x1300x2200
Max. Rotational Velocity (rpm)	80
Total Weight (kg)	320
Installed Power (Kw)	1,5
Power Supply Voltage (V)	230V 1Ph+N 50/60Hz

### PRODUCT SIZE TO PACK

Max. Length (mm)	No Limit
Min Length (mm) <b>with Bridge</b>	400
Max Passing Dimensions (mm)	Max W: 400 H: 150 W:250 Max H: 220

### CONVEYOR BELT FEATURES

Conveyor Belt Length (mm)	950
Conveyor Belt Width (mm)	190
Max. Conveyor Speed (m/sec)	12
Max. Load Capacity (kg/m)	50
Working Height (mm)	750

### STRETCH FILM FEATURES

Max. Exterior Diameter (mm)	200
Reeel Core Diameter (mm)	76
Max. Exterior Width (mm)	170/250
Recommended Thickness (micron)	12, 15, 17, 23, 30, 35
Max. Weight	3,6 kg

\*125/170mm reels can also be used

### CUSTOMISE YOUR MACHINE WITH:

- 7" Touch Panel
- Wifi/Mobile Access
- Barcode Program & Printer
- Conveyor Options
- Touch Series (Bubble/Foam Wrap)
- Manual Side Press
- Stretch Roture Warning System
- Fence Protection



## JOY 1250

"Compact and Easy to Own!"

### Standart Machine Includes:



Stretch Tensioner



Automatic Top Presses



Automatic Cutting System



Motorised Belt Conveyors

### MACHINE TECHNICAL SPECIFICATIONS

Net Passing Diameter (mm)	1260
Standart Dimensions (WxHxL)	2030x2250x2200
Max. Rotational Velocity (rpm)	70
Total Weight (kg)	560
Installed Power (Kw)	1,5
Power Supply Voltage (V)	230V 1Ph+N 50/60Hz

### PRODUCT SIZE TO PACK

Max. Length (mm)	No Limit
Min Length (mm) <b>with Bridge</b>	400
Max Passing Dimensions (mm)	Max W: 1130 H: 200 W:750 Max H: 670

### CONVEYOR BELT FEATURES

Conveyor Belt Length (mm)	950
Conveyor Belt Width (mm)	750
Max. Conveyor Speed (m/sec)	12
Max. Load Capacity (kg/m)	90
Working Height (mm)	720-880

### STRETCH FILM FEATURES

Max. Exterior Diameter (mm)	200
Reeel Core Diameter (mm)	76
Max. Exterior Width (mm)	170/250
Recommended Thickness (micron)	12, 15, 17, 23, 30, 35
Max. Weight	3,6 kg

\*125/170mm reels can also be used

### CUSTOMISE YOUR MACHINE WITH:



7" Touch Panel



Wifi/Mobile Access



Barcode Program & Printer



Conveyor Options



Touch Series



Stretch Roture Warning System



Fence Protection



## JOY 1550

"Wrap Any Cabinet: Where Precision Meets Versatility!"

### Standart Machine Includes:

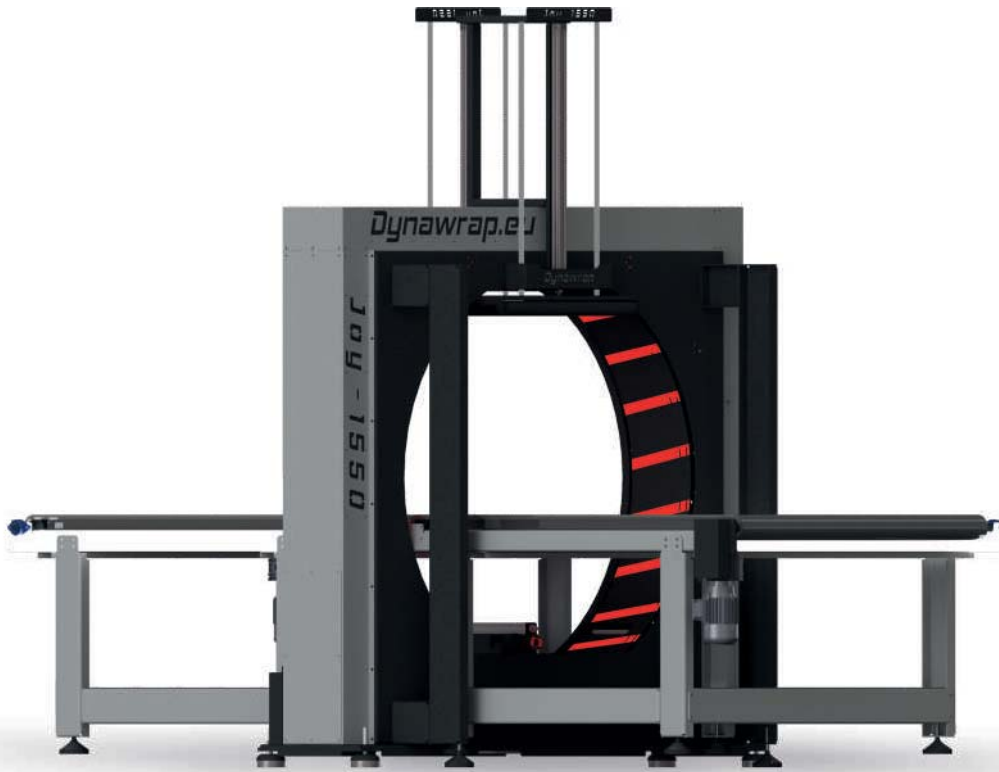

Stretch Tensioner



Automatic Top Presses



Automatic Cutting System



Motorised Belt Conveyors

### MACHINE TECHNICAL SPECIFICATIONS

Net Passing Diameter (mm)	1550
Standart Dimensions (WxHxL)	2200x2850x3750
Max. Rotational Velocity (rpm)	70
Total Weight (kg)	1120
Installed Power (Kw)	2,25
Power Supply Voltage (V)	230V 1Ph+N 50/60Hz

### PRODUCT SIZE TO PACK

Max. Length (mm)	No Limit
Min Length (mm) <b>with Bridge</b>	450
Max Passing Dimensions (mm)	Max W: 1420 H: 200 W:920 Max H: 870

### CONVEYOR BELT FEATURES

Conveyor Belt Length (mm)	1800
Conveyor Belt Width (mm)	900 (Std.) /1000 (Opt.)
Max. Conveyor Speed (m/sec)	12
Max. Load Capacity (kg/m)	90
Working Height (mm)	800-880

### STRETCH FILM FEATURES

Max. Exterior Diameter (mm)	200
Reeel Core Diameter (mm)	76
Max. Exterior Width (mm)	170/250
Recommended Thickness (micron)	12, 15, 17, 23, 30, 35
Max. Weight	3,6kg / 4,8kg

\*125/170mm reels can also be used

### CUSTOMISE YOUR MACHINE WITH:



7" Touch Panel



Wifi/Mobile Access



Barcode Program & Printer



Conveyor Options



Touch Series



Stretch Roture Warning System



Fence Protection



## PRO 600

"Pioneering Robustness at Lightning Speeds!"

### Standart Machine Includes:



7" Touch Panel



Stretch Tensioner+CTS



Automatic Top Presses



Automatic Cutting System



Motorised Belt Conveyors

### MACHINE TECHNICAL SPECIFICATIONS

Net Passing Diameter (mm)	600
Standart Dimensions (W x H x L) (mm)	1630x1500x2960
Max. Rotational Velocity (rpm)	90
Total Weight (kg)	560 kg
Installed Total Power (kw)	1,5
Power Supply Voltage (V)	400V 3Ph+N 50/60Hz

### PRODUCT SIZE TO PACK

Max. Length (mm)	No Limit
Min Length (mm) <b>with Bridge</b>	600
Max Passing Dimensions (mm)	Max W: 550 H: 150 W:400 Max H: 300

### CONVEYOR BELT FEATURES

Conveyor Belt Length (mm)	1500
Conveyor Belt Width (mm)	300
Max. Conveyor Speed (m/sec)	15
Max. Load Capacity (kg/m)	60
Working Height (mm)	800-850

### STRETCH FILM FEATURES

Max. Exterior Diameter (mm)	210
Reeel Core Diameter (mm)	76
Max. Exterior Width (mm)	170/250
Recommended Thickness (micron)	12, 15, 17, 23, 30, 35
Max. Weight	4,2 kg / 5,6 kg

\*125/170mm reels can also be used

### CUSTOMISE YOUR MACHINE WITH:



Wifi/Mobile Access



Barcode Program & Printer



Conveyor Options



Touch Series (Bubble/Foam Wrap)



Automatic Side Guides



Stretch Roture Warning System

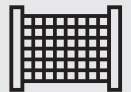

Fence Protection



# PRO 1100

"Power Moves!"

## Standart Machine Includes:

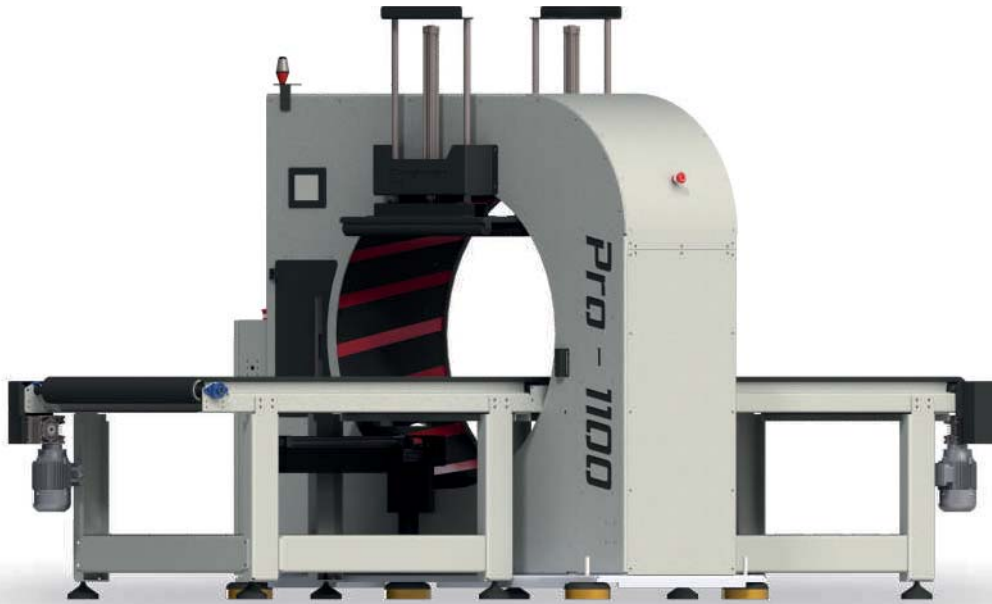

7" Touch Panel



Stretch Tensioner+CTS



Automatic Top Presses



Automatic Cutting System



Motorised Belt Conveyors

### MACHINE TECHNICAL SPECIFICATIONS

Net Passing Diameter (mm)	1100
Standart Dimensions (W x H x L) (mm)	1950x2100x4000
Max. Rotational Velocity (rpm)	90
Total Weight (kg)	820
Installed Total Power (kw)	2,25
Power Supply Voltage (V)	400V 3Ph+N 50/60Hz

### PRODUCT SIZE TO PACK

Max. Length (mm)	No Limit
Min Length (mm) <b>with Bridge (125mm Reel)</b>	300
Min Length (mm) <b>with Bridge (250mm Reel)</b>	550
Max Passing Dimensions (mm)	<u>Max W: 980 H: 100</u> <u>W: 700 Max H: 550</u>

### CONVEYOR BELT FEATURES

Conveyor Belt Length (mm)	1800
Conveyor Belt Width (mm)	750
Max. Conveyor Speed (m/sec)	12
Max. Load Capacity (kg/m)	90
Working Height (mm)	750-800

### STRETCH FILM FEATURES

Max. Exterior Diameter (mm)	210
Reeel Core Diameter (mm)	76
Max. Exterior Width (mm)	125*/ 170 /250
Recommended Thickness (micron)	12, 15, 17, 23, 30, 35
Max. Weight	2,8kg / 5,6kg

\*125mm Reel Machine. (Slim Type)  
\*125/170mm reels can also be used

### CUSTOMISE YOUR MACHINE WITH:



Wifi/Mobile Access



Barcode Program & Printer



Conveyor Options



Touch Series



Stretch Roture Warning System



Fence Protection



# PRO 1400

"Where Versatility Meets Performance Excellence"

## Standart Machine Includes:

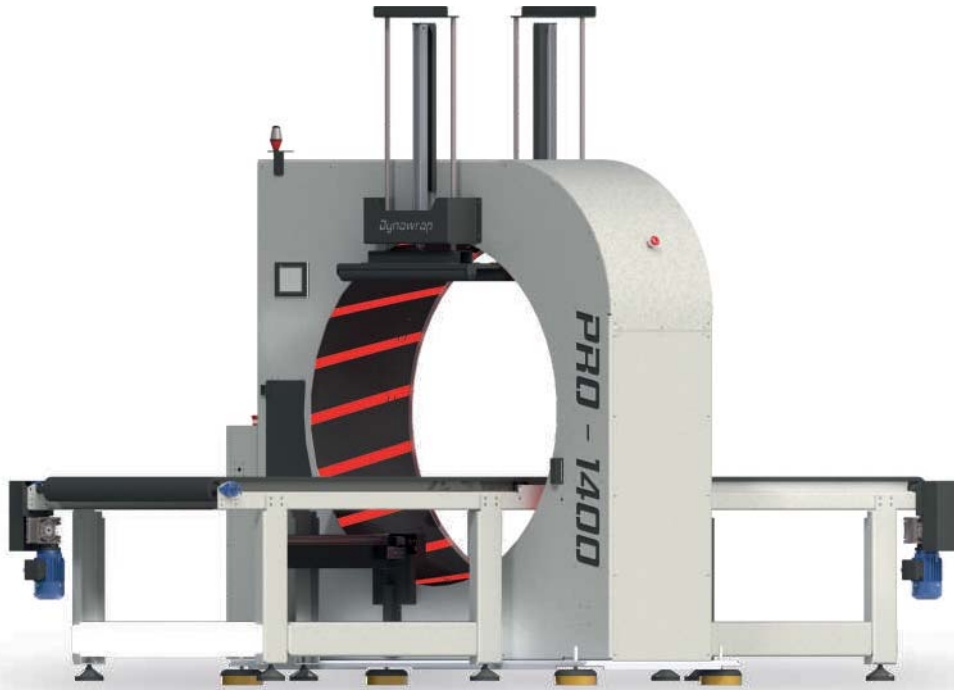

7" Touch Panel



Stretch Tensioner+CTS



Automatic Top Presses



Automatic Cutting System



Motorised Belt Conveyors

### MACHINE TECHNICAL SPECIFICATIONS

Net Passing Diameter (mm)	1370
Standart Dimensions (W x H x L) (mm)	2100x2600x4000
Max. Rotational Velocity (rpm)	75
Total Weight (kg)	1020
Installed Total Power (kw)	2,25
Power Supply Voltage (V)	400V 3Ph+N 50/60Hz

### PRODUCT SIZE TO PACK

Max. Length (mm)	No Limit
Min Length (mm) <b>with Bridge</b>	600
Max Passing Dimensions (mm)	Max W: 1290 H: 100 W: 800 Max H: 770

### CONVEYOR BELT FEATURES

Conveyor Belt Length (mm)	1800
Conveyor Belt Width (mm)	900 (Std.) /1000 (Opt.)
Max. Conveyor Speed (m/sec)	12
Max. Load Capacity (kg/m)	90
Working Height (mm)	750-850

### STRETCH FILM FEATURES

Max. Exterior Diameter (mm)	210
Reeel Core Diameter (mm)	76
Max. Exterior Width (mm)	250
Recommended Thickness (micron)	12, 15, 17, 23, 30, 35
Max. Weight	5,6kg

\*125/170mm reels can also be used

### CUSTOMISE YOUR MACHINE WITH:



Wifi/Mobile Access



Barcode Program & Printer



Conveyor Options



Touch Series



Stretch Roture Warning System

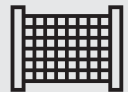

Fence Protection



## PRO 1700

"Ready for Big Things!"

### Standart Machine Includes:

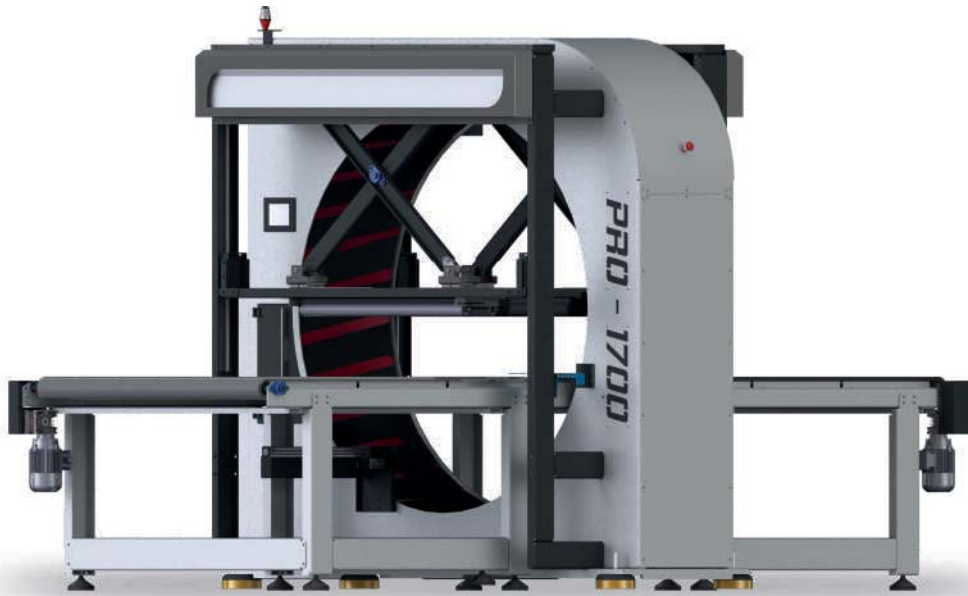

7" Touch Panel



Stretch Tensioner+CTS



Automatic Top Presses



Automatic Cutting System



Motorised Belt Conveyors

### MACHINE TECHNICAL SPECIFICATIONS

Net Passing Diameter (mm)	1700
Standart Dimensions (W x H x L) (mm)	2470x2300x4000
Max. Rotational Velocity (rpm)	55
Total Weight (kg)	1480
Installed Total Power (kw)	3,0
Power Supply Voltage (V)	400V 3Ph+N 50/60Hz

### PRODUCT SIZE TO PACK

Max. Length (mm)	No Limit
Min Length (mm) <b>with Bridge</b>	750
Max Passing Dimensions (mm)	Max W: 1580 H: 150 W: 800 Max H: 1050

### CONVEYOR BELT FEATURES

Conveyor Belt Length (mm)	1800
Conveyor Belt Width (mm)	1300
Max. Conveyor Speed (m/sec)	12
Max. Load Capacity (kg/m)	100
Working Height (mm)	800-900

### STRETCH FILM FEATURES

Max. Exterior Diameter (mm)	230
Reeel Core Diameter (mm)	76
Max. Exterior Width (mm)	250
Recommended Thickness (micron)	15, 17, 23, 30, 35
Max. Weight	6,5kg

\*125/170mm reels can also be used

### CUSTOMISE YOUR MACHINE WITH:



Wifi/Mobile Access



Barcode Program & Printer



Conveyor Options



Touch Series  
(Bubble/Foam Wrap)



Stretch Roture  
Warning System



Fence Protection



# PRO 2200

"Where Size Meets Power!"

## Standart Machine Includes:

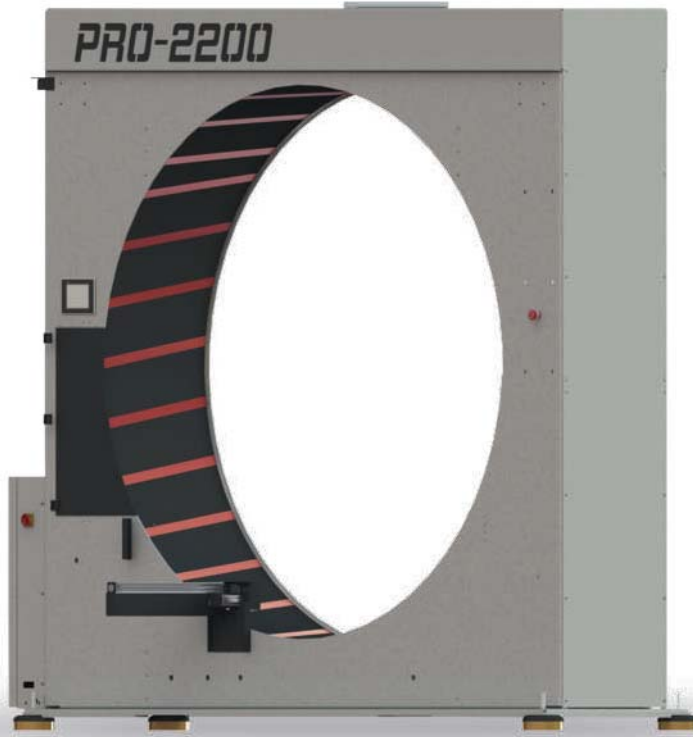

7" Touch Panel



Stretch Tensioner+CTS



Automatic Cutting System

### MACHINE TECHNICAL SPECIFICATIONS

Net Passing Diameter (mm)	2170
Standart Dimensions (W x H x L) (mm)	3200x2850x2100
Max. Rotational Velocity (rpm)	55
Total Weight (kg)	2800
Installed Total Power (kw)	3,0
Power Supply Voltage (V)	400V 3Ph+N 50/60Hz

### PRODUCT SIZE TO PACK

Max. Length (mm)	No Limit
Min Length (mm) <b>with Bridge</b>	750
Max Passing Dimensions (mm)	Max W: 1500 H: 1200

### CONVEYOR BELT FEATURES

Conveyor Belt Length (mm)	Customizable
Conveyor Belt Width (mm)	Customizable
Max. Load Capacity (kg/m)	Customizable
Working Height (mm)	850-950

### STRETCH FILM FEATURES

Max. Exterior Diameter (mm)	235
Reeel Core Diameter (mm)	76
Max. Exterior Width (mm)	250/500
Recommended Thickness (micron)	17, 23, 30, 35
Max. Weight	8 kg / 15 kg

*\*250/500 mm reels can also be used.*

### CUSTOMISE YOUR MACHINE WITH:



Wifi/Mobile Access



Barcode Program & Printer



Conveyor Options



Stretch Roture Warning System

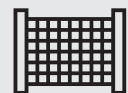

Fence Protection





# PRO 1100W

"Foam to Bubble, Total Versatility in Every Wrap!"

## Standart Machine Includes:



7" Touch Panel



Stretch Tensioner+CTS



Automatic Top Presses



Automatic Cutting System



Motorised Belt Conveyors

### MACHINE TECHNICAL SPECIFICATIONS

Net Passing Diameter (mm)	1100
Standart Dimensions (W x H x L) (mm)	1950x2100x6000
Max. Rotational Velocity (rpm)	90
Total Weight (kg)	1320
Installed Total Power (kw)	3,3
Power Supply Voltage (V)	400V 3Ph+N 50/60Hz

### PRODUCT SIZE TO PACK

Max. Length (mm)	No Limit
Min Length (mm) <b>with Bridge</b>	550
Max Passing Dimensions (mm)	Max W: 980 H: 100 W: 700 Max H: 550

### AIR BUBBLE FILM

Max. Film Width (mm)	950
Max. Diameter (mm)	650
Core Diameter (mm)	20-76
Welding Temperature (°C) Digital	60-180
Materials Confirmed	PE Film, Foam, PE Air Bubble, PVC, Shrink Film

### CONVEYOR BELT FEATURES

Conveyor Belt Length (mm)	1800/1800/1800
Conveyor Belt Width (mm)	750
Max. Conveyor Speed (m/sec)	12
Max. Load Capacity (kg/m)	90
Working Height (mm)	750-800

### STRETCH FILM FEATURES

Max. Exterior Diameter (mm)	220
Reeel Core Diameter (mm)	76
Max. Exterior Width (mm)	250
Recommended Thickness (micron)	12, 15, 17, 23, 30, 35
Max. Weight	5,6kg

\*125/170mm reels can also be used

### CUSTOMISE YOUR MACHINE WITH:



Wifi/Mobile Access



Barcode Program & Printer



Conveyor Options



Stretch Roture Warning System



Fence Protection



## PRO 1400W

"Foam to Bubble, Total Versatility in Every Wrap!"

### Standart Machine Includes:



7" Touch Panel



Stretch Tensioner+CTS



Automatic Top Presses



Automatic Cutting System



Motorised Belt Conveyors

### MACHINE TECHNICAL SPECIFICATIONS

Net Passing Diameter (mm)	1370
Standart Dimensions (W x H x L) (mm)	2100x2600x6000
Max. Rotational Velocity (rpm)	75
Total Weight (kg)	1630
Installed Total Power (kw)	3,7
Power Supply Voltage (V)	400V 3Ph+N 50/60Hz

### PRODUCT SIZE TO PACK

Max. Length (mm)	No Limit
Min Length (mm) <b>with Bridge</b>	600
Max Passing Dimensions (mm)	Max W: 1290 H: 100 W: 800 Max H: 750

### AIR BUBBLE FILM

Max. Film Width (mm)	1350
Max. Diameter (mm)	650
Core Diameter (mm)	20-76
Welding Temperature (°C) Digital	60-180
Materials Confirmed	PE Film, Foam, PE Air Bubble, PVC, Shrink Film

### CONVEYOR BELT FEATURES

Conveyor Belt Length (mm)	1800/1800/1800
Conveyor Belt Width (mm)	900 (Std.) /1000 (Opt.)
Max. Conveyor Speed (m/sec)	12
Max. Load Capacity (kg/m)	90
Working Height (mm)	750-800

### STRETCH FILM FEATURES

Max. Exterior Diameter (mm)	210
Reeel Core Diameter (mm)	76
Max. Exterior Width (mm)	250
Recommended Thickness (micron)	12, 15, 17, 23, 30, 35
Max. Weight	5,6kg

\*125/170mm reels can also be used

### CUSTOMISE YOUR MACHINE WITH:



Wifi/Mobile Access



Barcode Program & Printer



Conveyor Options



Stretch Roture Warning System



Fence Protection



## PRO 1700W

"Foam to Bubble, Total Versatility in Every Wrap!"

Standart Machine Includes:

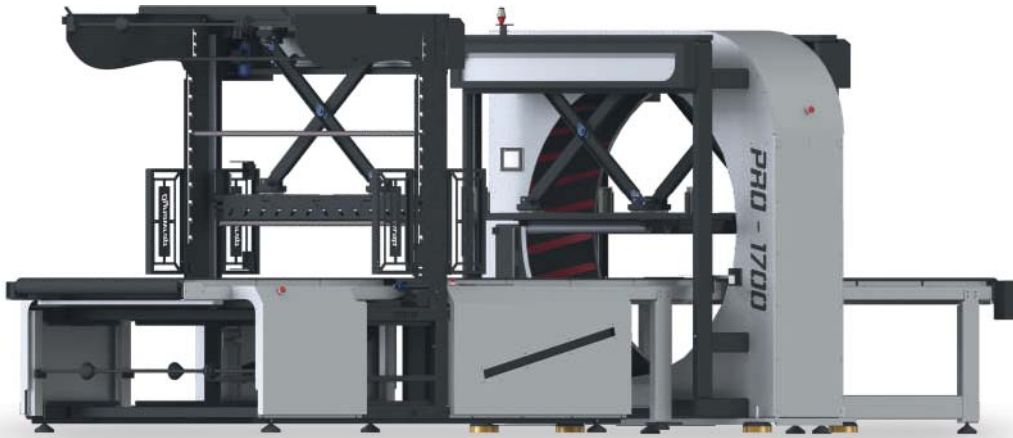

7" Touch Panel



Stretch Tensioner+CTS



Automatic Top Presses



Automatic Cutting System



Motorised Belt Conveyors

### MACHINE TECHNICAL SPECIFICATIONS

Net Passing Diameter (mm)	1700
Standart Dimensions (W x H x L) (mm)	2470x2300x6640
Max. Rotational Velocity (rpm)	55
Total Weight (kg)	2300
Installed Total Power (kw)	4,7
Power Supply Voltage (V)	400V 3Ph+N 50/60Hz

### PRODUCT SIZE TO PACK

Max. Length (mm)	No Limit
Min Length (mm) <b>with Bridge</b>	750
Max Passing Dimensions (mm)	Max W: 1580 H: 150 W: 800 Max H: 930

### AIR BUBBLE FILM

Max. Film Width (mm)	1600
Max. Diameter (mm)	650
Core Diameter (mm)	20-76
Welding Temperature (°C) Digital	60-180
Materials Confirmed	PE Film, Foam, PE Air Bubble, PVC, Shrink Film

### CONVEYOR BELT FEATURES

Conveyor Belt Length (mm)	1800/2400/1800
Conveyor Belt Width (mm)	1300
Max. Conveyor Speed (m/sec)	12
Max. Load Capacity (kg/m)	90
Working Height (mm)	800-900

### STRETCH FILM FEATURES

Max. Exterior Diameter (mm)	220
Reeel Core Diameter (mm)	76
Max. Exterior Width (mm)	250
Recommended Thickness (micron)	12, 15, 17, 23, 30, 35
Max. Weight	6,3kg

\*125/170mm reels can also be used

### CUSTOMISE YOUR MACHINE WITH:



Wifi/Mobile Access



Barcode Program & Printer



Conveyor Options



Stretch Roture Warning System



Fence Protection